

T3 Series Bacnet Programmable Controller

T3000 controller is a multi-user, including T3-BB, T3-LB and T3-TB. It can stand DDC panel alone or in a multiple network system with full communication capabilities. The multiple communication ports allow the controller to operate on a network or host sub networks and to communicate with local and remote operators simultaneously.

Setup and programming are done on a PC not necessary to connect to live hardware as it is the case with many systems. When the program is ready for on-site testing, connect it to a live panel and download the T3000 software. Programming can be done remotely over the network and modem connections as well. The network system is very flexible and economical for the installation.



T3-BB



T3-TB



T3-LB



T3 Series Bacnet Programmable Controller

Specifications

Industry standard	Bacnet & Modbus protocols
Control Basic programs	16
User screen displays	16
Schedule&holiday	8 Weekly routines, 4 annual routines
User variables	128
PID Controllers	16
Passwords or users	8
RS485 Sub baudrates	9600 thru to 115k
RS485 main baudrates	1200~921600
Main CPU capacity	512K Flash / 512k Ram
Highly Configurable	any combination of input/output cards totalling up to 64 points
Digital output	5V/125VAC, 30DVC
Analog output	0-10V
Universal input	Thermistor, 0-10V, 0-5V, 0-20mA
Mechanical relays	2A, 24VAC/DC
Diagnostic LEDS	Hand-Off-Auto Switches
SD Disk slot	Trend logs, alarms, graphics
Ethernet Port	Bacnet & Modbus supported simultaneously
RS485 Ports	2
USB Port	T3-BB, T3-LB
RS232 Port	T3-BB
Hardware Options	Several optional modules are available to support Zigbee ,Wifi, 1k Pt sensor inputs.
Wifi Security	WEP/WPA-PSK/WPA2-PSK
Operating Temperature	-30~70°C (-22~158°F)
Maximum Power Consumption	T3-BB:10W T3-LB:10W T3-TB:6W
Case Color	Black

- Surge-protected Universal Inputs with 12-bit resolution
 - UL listed ABS enclosure with rubberized texture creates a high end feel.
 - Software configure the I/O ranges with the free T3000 software or by writing to the registers with your own software.
 - Each output has a hand-off-auto switch for easy troubleshooting and overrides.
 - Each I/O as well as the RS485 connections have a separate screw terminal, there's no need to gang two wires under one terminal for any of the terminations.
 - High/Low speed input pulse counters
 - Communication methods are RS485, Ethernet, USB, Zigbee but it can, at the same time, support Modbus and Bacnet.
 - Starter space source code is available.
 - T3000 front end is free and open source: <http://tinyurl.com/n7kkqp6>
 - Compiled version of the front end is here: <https://tinyurl.com/y7uyu9n3>
 - Interactive dynamic color graphics
 - User programming, built in networking features
- [https:// www.bravocontrols.com/ftp/software/09T3000Software.zip](https://www.bravocontrols.com/ftp/software/09T3000Software.zip)

T3 Series Bacnet Programmable Controller

Part Number Scheme

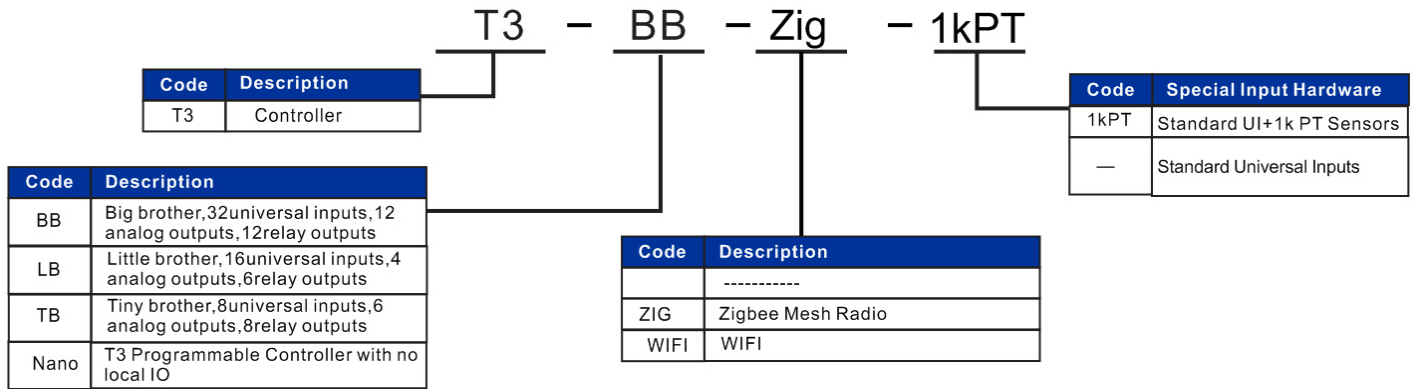

Network Diagram

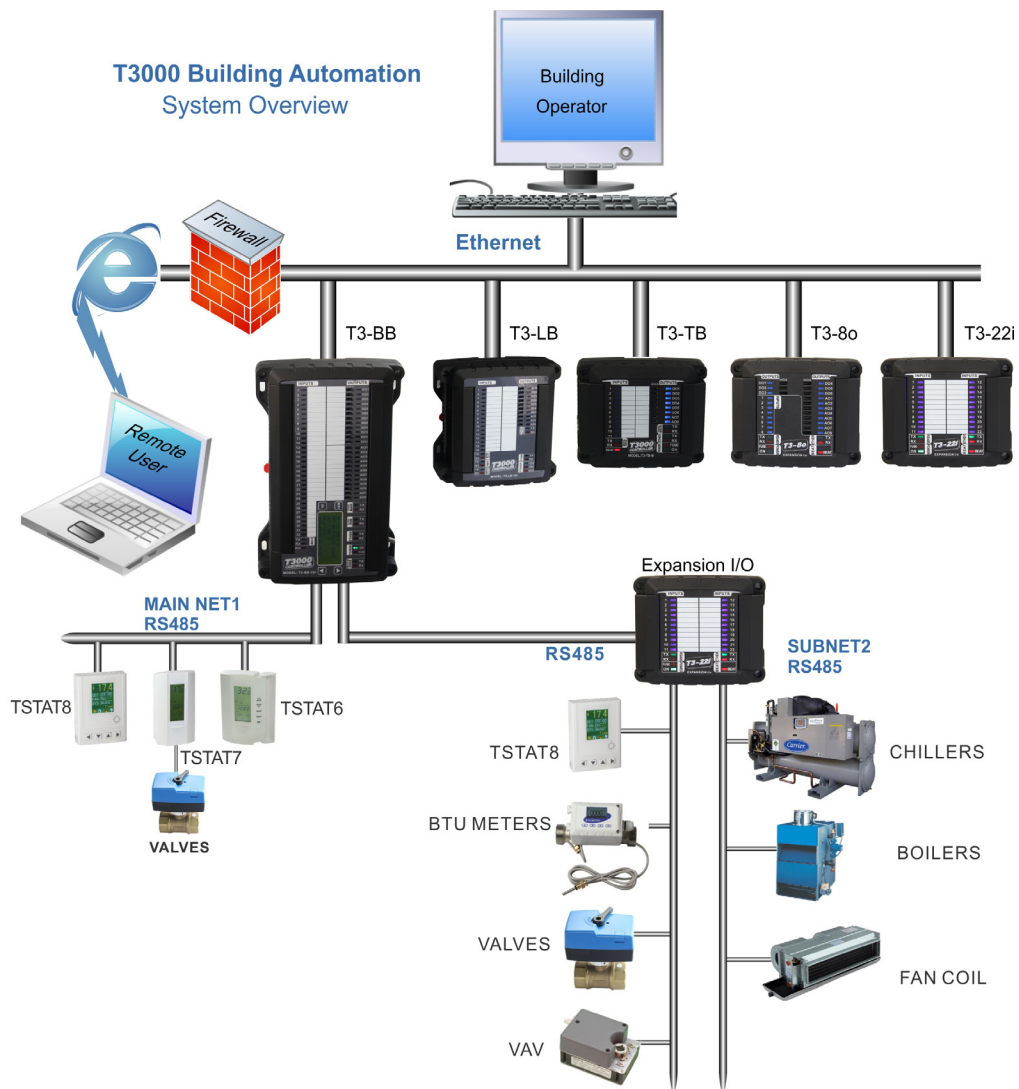

T3 Series Bacnet Programmable Controller

Dimensions

1) T3-BB(Big Brother)

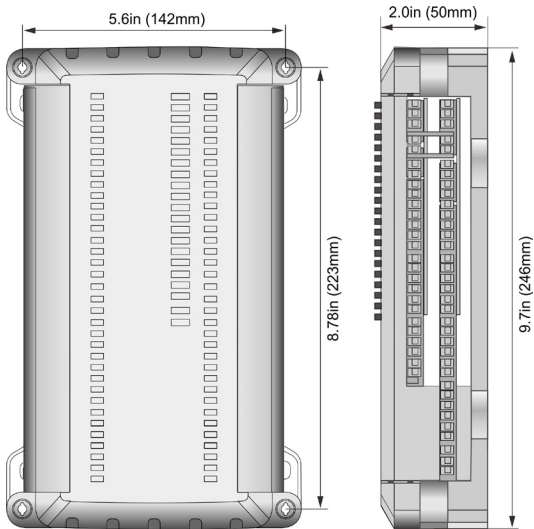

2) T3-LB(Little Brother)

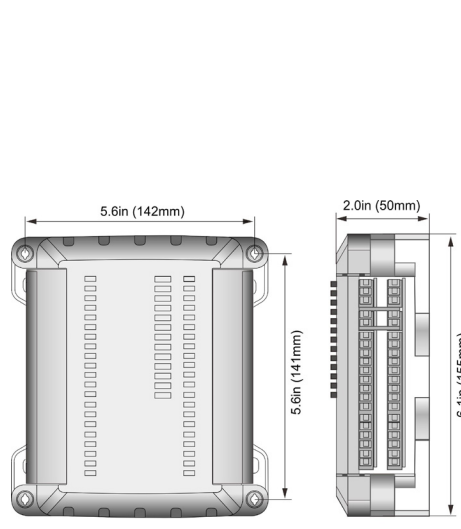

2) T3-TB(Little Brother)

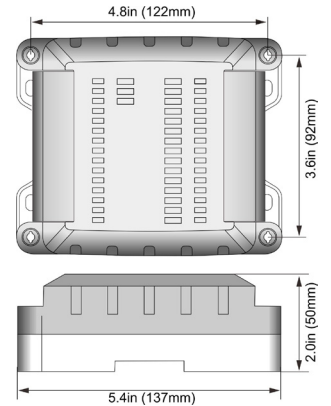

Wiring Diagram

T3-LB Wiring Diagram

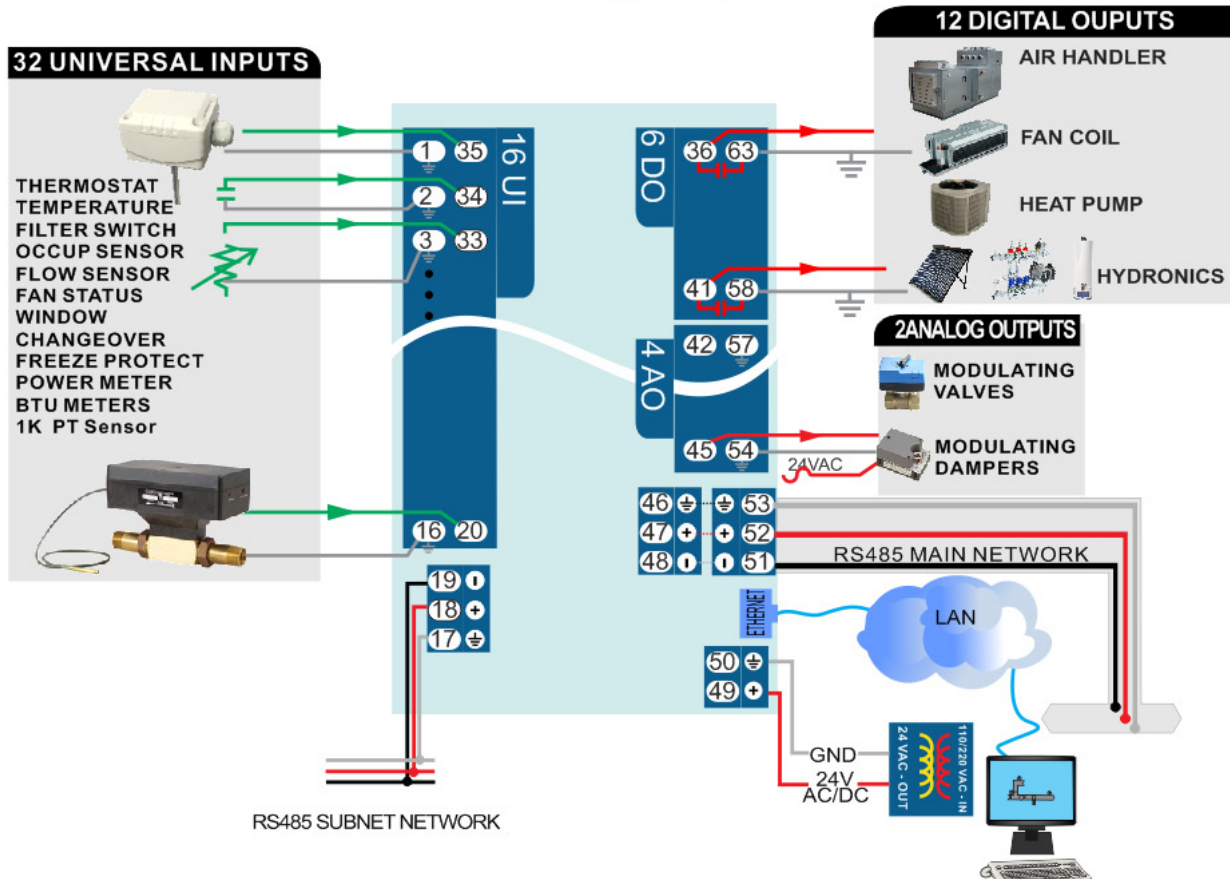

T3 Series Bacnet Programmable Controller

T3-BB WIRING DIAGRAM

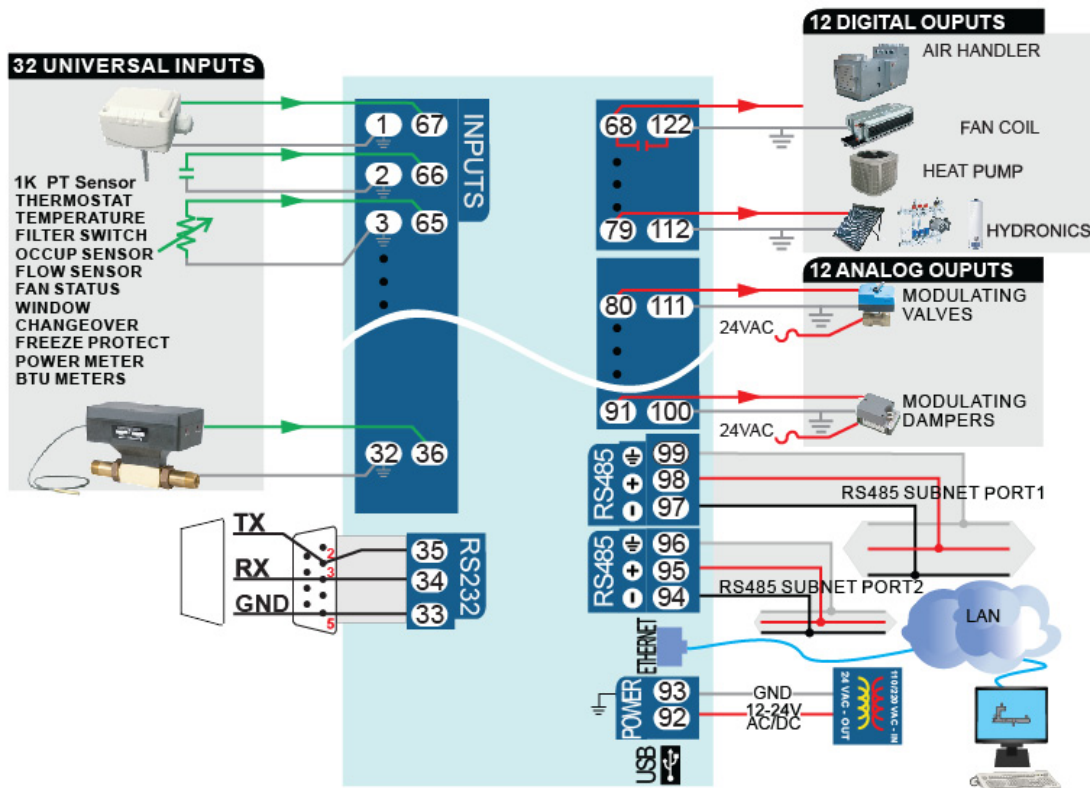

T3-TB WIRING DIAGRAM

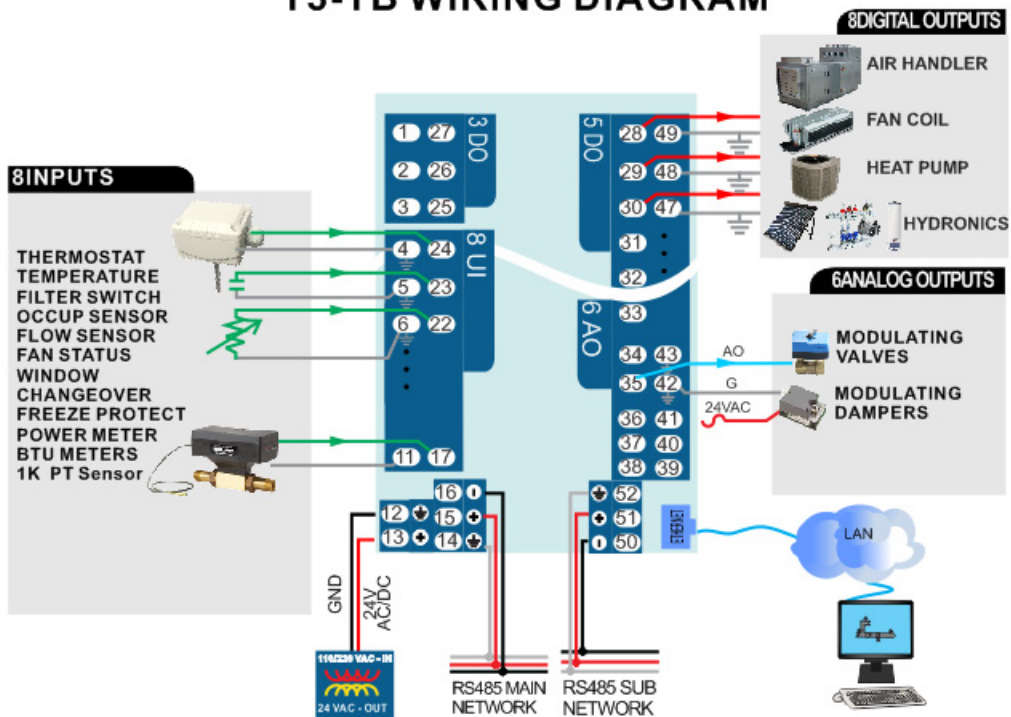

* zigbee module.

	Controller			
	T3-BB Big Brother	T3-LB Little Brother	T3-TB Tiny Brother	T3-Nano
Total Channels:	56	26	22	/
Universal Input	32	16	8	/
Analog Output	12	4	6	/
Relay Output	12	6	8	/
Comm ports:				
RS485	2	2	2	2
RS232	1	0	0	0
Ethernet	1	1	1	1
USB	1	1	0	0
Option port**	1	1	0	0

Transportation methods of these units are RS485, Ethernet, USB, Zigbee, at the same time, they support Modbus and Bacnet. The T3-BB unit features 32 channels input and 24 channels output including 12 channels analog output and 12 channels digital output. As for the T3-LB, there are 16 channels input and 10 channels output including 4 channels analog output and 6 channels digital output. For T3-TB, it includes 8 inputs and 14 outputs which contain 6 analog outputs, 8 digital outputs. All of these channels can be controlled directly by minipanel through input and output cards.

Highlight

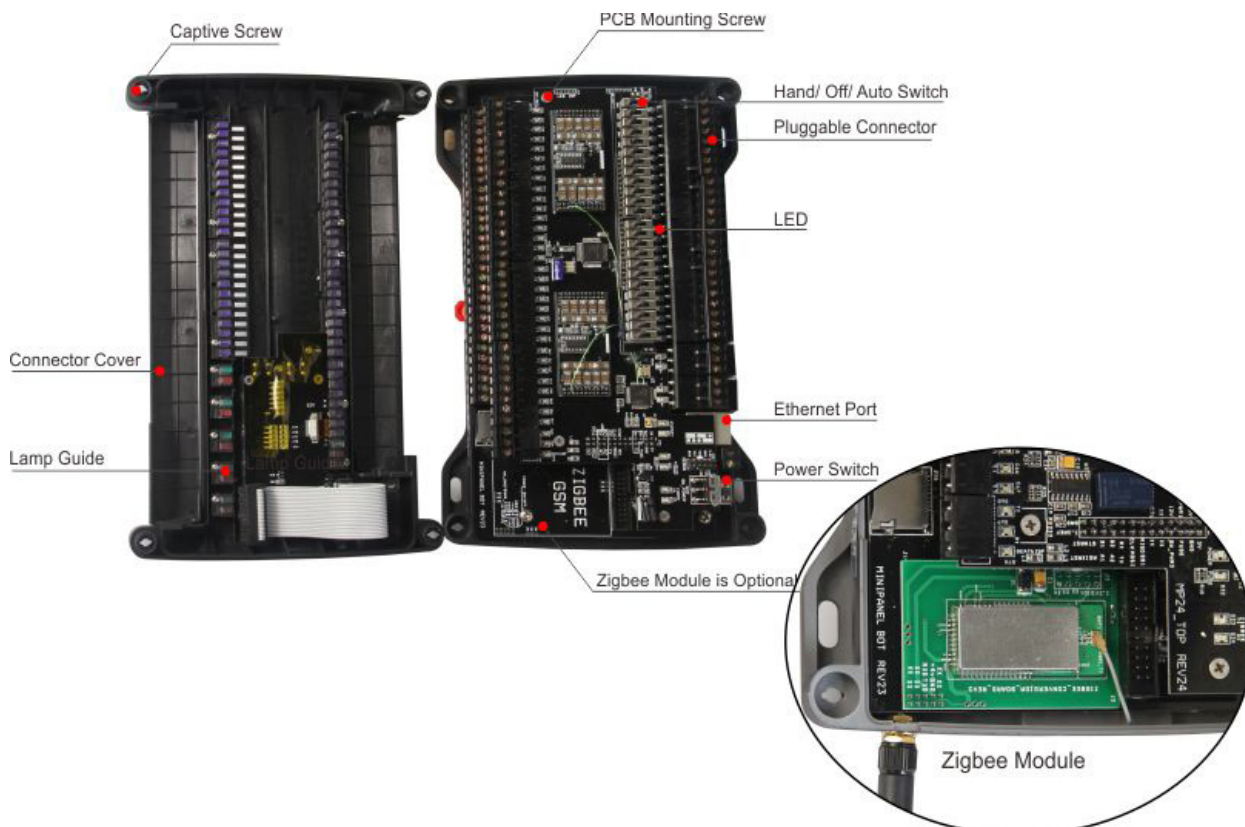

T3 Series Bacnet Programmable Controller

T3000 Operation Instructions

1. Visit <https://tinyurl.com/y7uyu9n3>, download 09T3000 software.zip and install it;
2. Take an example of T3-BB here, connect T3-BB to PC by RS485 network at pin 94, 95, and 96 or Ethernet.
3. Open T3000 software, and click icon building, an popup window will appear, set protocol to Auto, then close it. Click scan icon which is next to the icon building to find the connected unit.

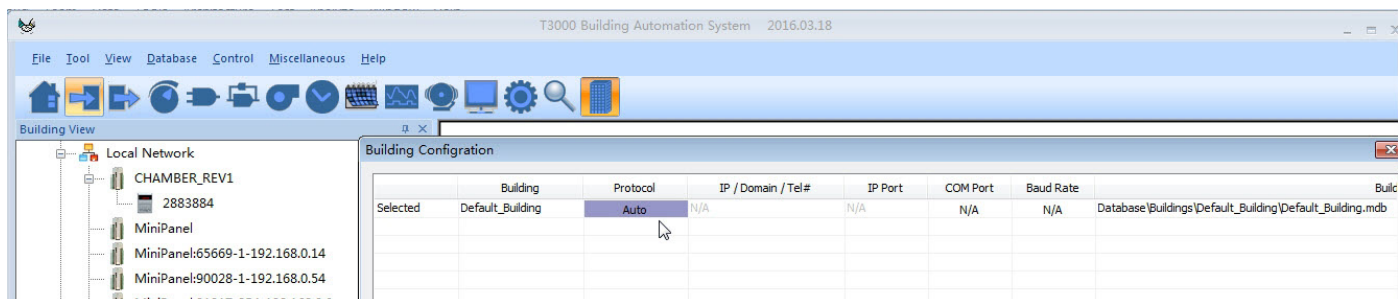

1. Click to scan

Device detected

2. Click to close

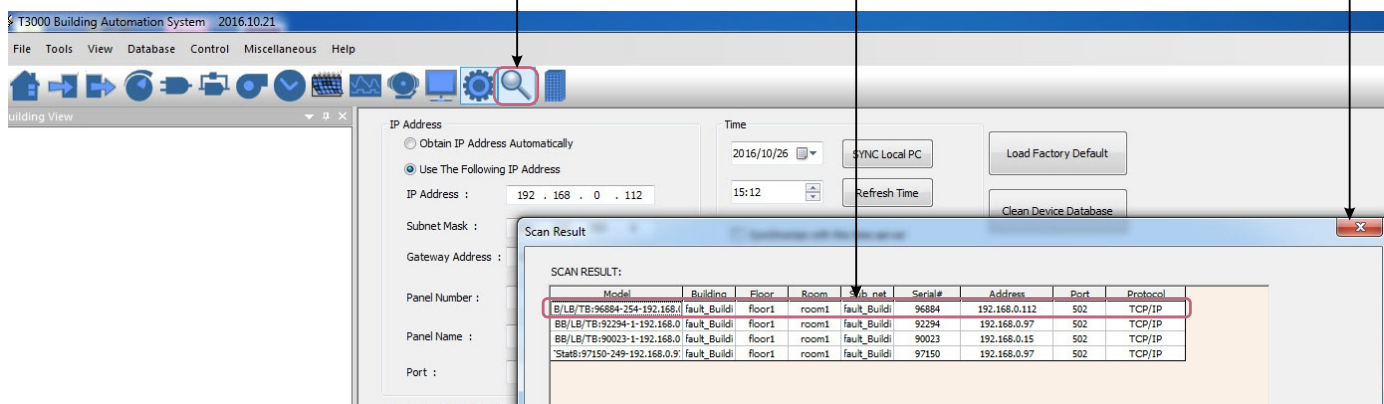

Then click the device log what have been connected, T3000 software will show the info in right hand place. You can click Input, Output and other icon.

4. Click input to show table right

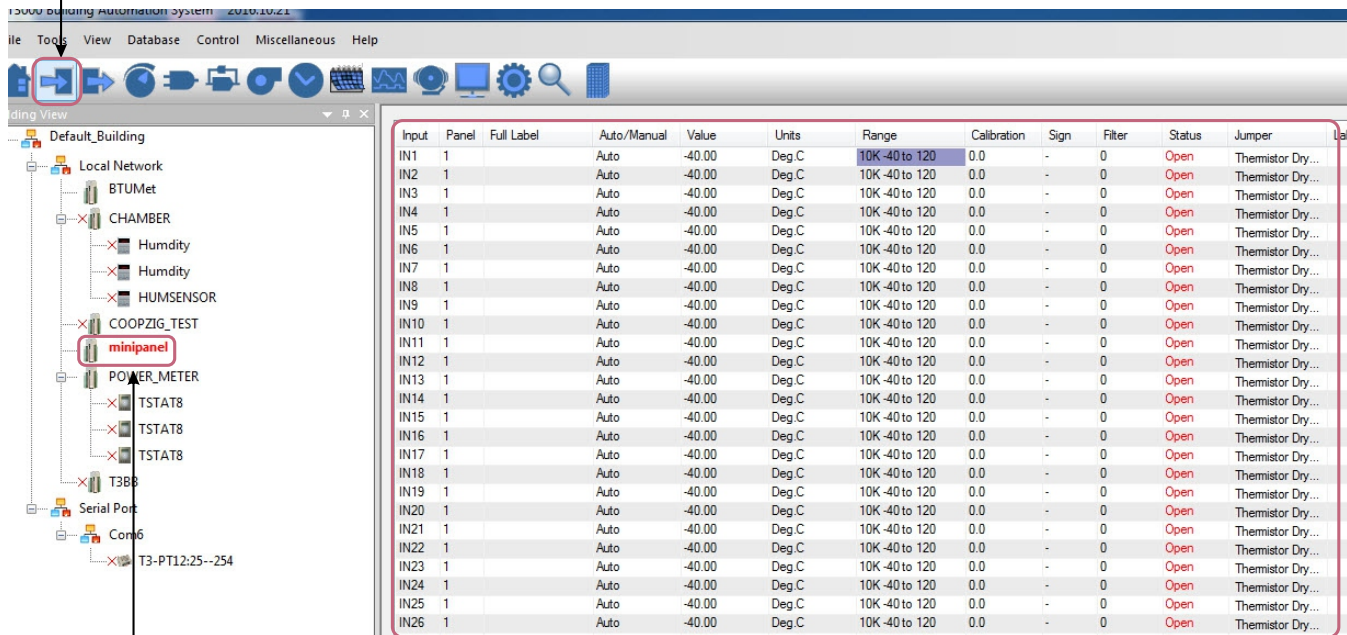

3. Click to select minipanel

T3 Series Bacnet Programmable Controller

4. Click input icon, it will show all inputs in T3000 software.

	T3-BB	T3-LB	T3-TB	Speed
Low Speed Input channels	1-32	1-16	1-8	1 Hz
High Speed Input channels	27-32	11-16	/	1KHz

For T3-BB, T3-LB, T3-TB, all the inputs channels have pulse counters. High speed counters capable of 1M Hz. Low speed inputs channels reach to 1 hz per channel.

Here we take an example of T3-BB, showing how to configure the high speed and low speed counters in T3000 software.

5. Click input to show table below

The screenshot shows the T3000 Building Automation System interface. On the left is a tree view of the building structure. The main window displays a table of inputs:

Input	Panel	Full Label	Auto/Manual	Value	Units	Range	Calibration	Sign	Filter	Status	Jumper	Label
IN1	1	Auto	Auto	-40.00	Deg.C	10K -40 to 120	0.0	-	0	Open		Thermistor Dry...
IN2	1	Auto	Auto	-40.00	Deg.C	10K -40 to 120	0.0	-	0	Open		Thermistor Dry...
IN3	1	Auto	Auto	-40.00	Deg.C	10K -40 to 120	0.0	-	0	Open		Thermistor Dry...
IN4	1	Auto	Auto									
IN5	1	Auto	Auto									
IN6	1	Auto	Auto									
IN7	1	Auto	Auto									
IN8	1	Auto	Auto									
IN9	1	Auto	Auto									
IN10	1	Auto	Auto									
IN11	1	Auto	Auto									
IN12	1	Auto	Auto									
IN13	1	Auto	Auto									
IN14	1	Auto	Auto									
IN15	1	Auto	Auto									
IN16	1	Auto	Auto									
IN17	1	Auto	Auto									
IN18	1	Auto	Auto									
IN19	1	Auto	Auto									
IN20	1	Auto	Auto									
IN21	1	Auto	Auto									
IN22	1	Auto	Auto									
IN23	1	Auto	Auto									
IN24	1	Auto	Auto									
IN25	1	Auto	Auto									
IN26	1	Auto	Auto									
IN27	1	Auto	Auto									
IN28	1	Auto	Auto									
IN29	1	Auto	Auto									
IN30	1	Auto	Auto									
IN31	1	Auto	Auto									
IN32	1	Auto	Auto									

The 'Select Range Number' dialog box is open, showing 'Enter Units Number: 45' and 'Speed Count' selected. The dialog also lists various digital and input analog units, with '45. Low Speed Count' selected.

T3 Series Bacnet Programmable Controller

5. Click output icon, it will show the output view.

Click input to show table below

The screenshot displays the T3000 Building Automation System software interface. The title bar reads "T3000 Building Automation System 2016.10.21". The menu bar includes "File", "Tools", "View", "Database", "Control", "Miscellaneous", and "Help". The toolbar contains various icons, with the "Output" icon (a monitor with a gear) highlighted by a red circle. A callout box with the text "Click input to show table below" points to this icon. The main window is titled "building View" and is divided into two panes. The left pane, "building View", shows a hierarchical tree structure of the building system, including "Default_Building", "Local Network", "BTUMet", "CHAMBER", "Humidity", "HUMSENSOR", "COOPZIG_TEST", "minipanel", "POWER_METER", "TSTAT8", "T3BB", "Serial Port", and "Com6". The right pane displays a table of output parameters.

Output	Panel	Full Label	Auto/Manual	HOA Switch	Value	Units	Range	PWM Period	Status	Label
OUT1	1		Auto	MAN-ON	On		Off/On	0	OK	
OUT2	1		Auto	MAN-ON	On		Off/On	0	OK	
OUT3	1		Auto	MAN-ON	On		Off/On	0	OK	
OUT4	1		Auto	MAN-ON	On		Off/On	0	OK	
OUT5	1		Auto	MAN-ON	On		Off/On	0	OK	
OUT6	1		Auto	MAN-ON	On		Off/On	0	OK	
OUT7	1		Auto	MAN-ON	On		Off/On	0	OK	
OUT8	1		Auto	MAN-ON	On		Off/On	0	OK	
OUT9	1		Auto	MAN-ON	On		Off/On	0	OK	
OUT10	1		Auto	MAN-ON	On		Off/On	0	OK	
OUT11	1		Auto	MAN-ON	On		Off/On	0	OK	
OUT12	1		Auto	MAN-ON	On		Off/On	0	OK	
OUT13	1		Auto	MAN-ON	10.00	Volts	0.0 -> 10	0	OK	
OUT14	1		Auto	MAN-ON	10.00	Volts	0.0 -> 10	0	OK	
OUT15	1		Auto	MAN-ON	10.00	Volts	0.0 -> 10	0	OK	
OUT16	1		Auto	MAN-ON	10.00	Volts	0.0 -> 10	0	OK	
OUT17	1		Manual	MAN-ON	10.00	Volts	0.0 -> 10	0	OK	
OUT18	1		Manual	MAN-ON	10.00	Volts	0.0 -> 10	0	OK	
OUT19	1		Auto	MAN-ON	10.00	Volts	0.0 -> 10	0	OK	
OUT20	1		Manual	MAN-ON	10.00	Volts	0.0 -> 10	0	OK	
OUT21	1		Manual	MAN-ON	10.00	Volts	0.0 -> 10	0	OK	
OUT22	1		Manual	MAN-ON	10.00	Volts	0.0 -> 10	0	OK	
OUT23	1		Manual	MAN-ON	10.00	Volts	0.0 -> 10	0	OK	
OUT24	1		Manual	MAN-ON	10.00	Volts	0.0 -> 10	0	OK	
OUT25	1		Auto	AUTO	0.00		Unused	0	-	
OUT26	1		Auto	AUTO	0.00		Unused	0	-	
OUT27	1		Auto	AUTO	0.00		Unused	0	-	
OUT28	1		Auto	AUTO	0.00		Unused	0	-	
OUT29	1		Auto	AUTO	0.00		Unused	0	-	
OUT30	1		Auto	AUTO	0.00		Unused	0	-	
OUT31	1		Auto	AUTO	0.00		Unused	0	-	
OUT32	1		Auto	AUTO	0.00		Unused	0	-	
OUT33	1		Auto	AUTO	0.00		Unused	0	-	

*6.Steps to get zigbee information by T3000.

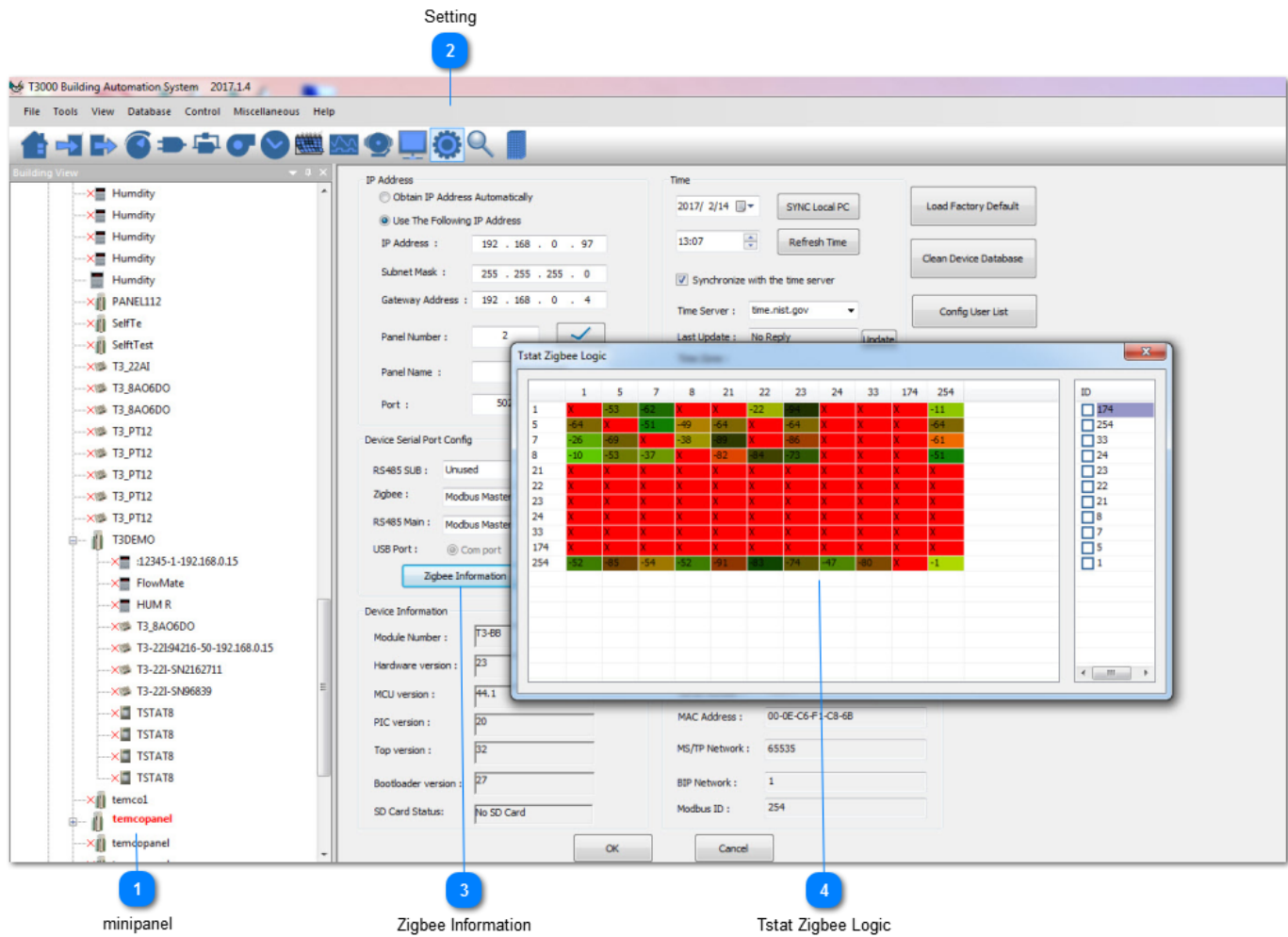

1

minipanel



Click to select minipanel

2

Setting



Click to show tab below

3

Zigbee Information

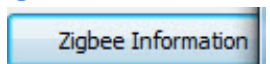

Click to show Tstat Zigbee Logic

4

Tstat Zigbee Logic

	1	5	7	8	21	22	23	24	33	174	254
1	X	-53	-62	X	X	-22	-94	X	X	X	-11
5	-64	X	-51	-49	-64	X	-64	X	X	X	-64
7	-26	-69	X	-38	-69	X	-86	X	X	X	-61
8	-10	-53	-37	X	-82	-84	-73	X	X	X	-51
21	X	X	X	X	X	X	X	X	X	X	X
22	X	X	X	X	X	X	X	X	X	X	X
23	X	X	X	X	X	X	X	X	X	X	X
24	X	X	X	X	X	X	X	X	X	X	X
33	X	X	X	X	X	X	X	X	X	X	X
174	X	X	X	X	X	X	X	X	X	X	X
254	-52	-85	-54	-52	-91	-93	-74	-47	-80	X	-1

It shows the information details

To read the zigbee signal for the T3 controller, read registers 5030 thru 5099. 5031~5099 are ID and signal strength, high byte is ID, low byte is signal strength. Register 5030 holds the number of neighbors the controller can see, let's say there are three thermostats near the T3 controller so N=3.

Register 5031 holds the Modbus ID and signal strength of the first neighbor, high byte is ID, low byte is signal strength.

Register 5032 holds the Modbus ID and signal strength of the second neighbor, high byte is ID, low byte is signal strength.

Register 5033 holds the Modbus ID and signal strength of the third neighbor, high byte is ID, low byte is signal strength.

.....

To read the signal strength for any of the thermostats, the same applies but the table starts at register 51, this holds the number of neighbors for the thermostat. Let's use N=3 again. Register 52 thru 54 holds the Modbus ID of the three neighbors. Register 55 thru 57 holds the signal strength of the three neighbors.

*You can also get the detail information using Temco Modbus Poll tool.

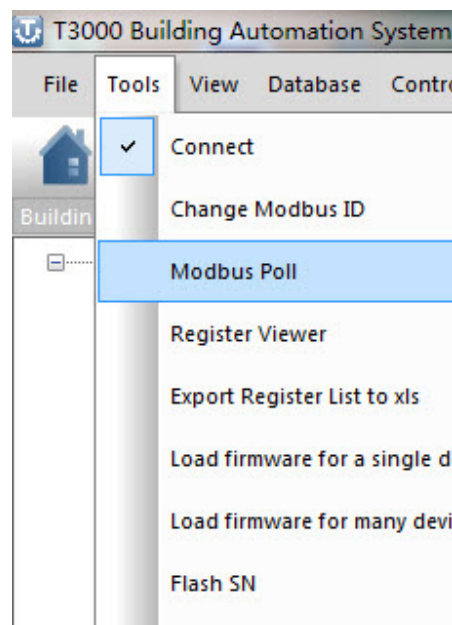

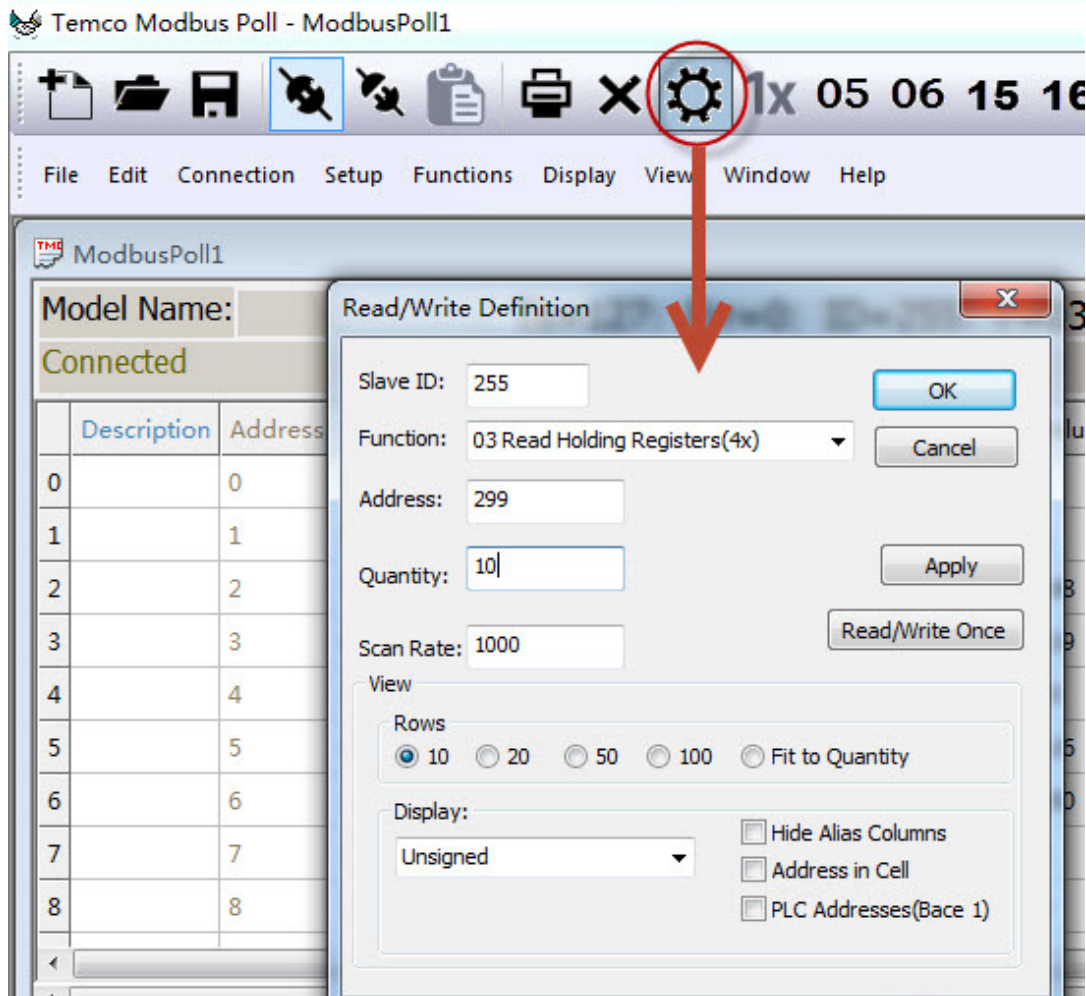

ID 255 means reading zigbee BB itself. Address 299 indicates how many units are connecting

For this test, there are 3 units connecting:

reg300: ID + 256 of unit 1, the highest bit set to 1 means that device is online, if it is off line, reg300 = ID = 18

It's the same for reg301 and 302 and so on.

Description	Address	Value
TOTAL NO	299	3
SUBADDR.F	300	274
SUBADDR.L	301	265
SUBADDR.L	302	262
SUBADDR.L	303	0
SUBADDR.L	304	0
SUBADDR.L	305	0
SUBADDR.L	306	0
SUBADDR.L	307	0
SUBADDR.L	308	0

For debugging:

1. First make sure the zigbee unit is connected to the zigbee network, when it is connected you can see the red led keeps on, otherwise it will be flashing.
2. In these two situations you can try to re-power the zigbee BB
 - A. If you wait for a long time the zigbee BB cannot find the units
 - B. If you find the units by T3000, but when you click the unit icon you can not access them.
3. Using modbus poll to access each of the unit

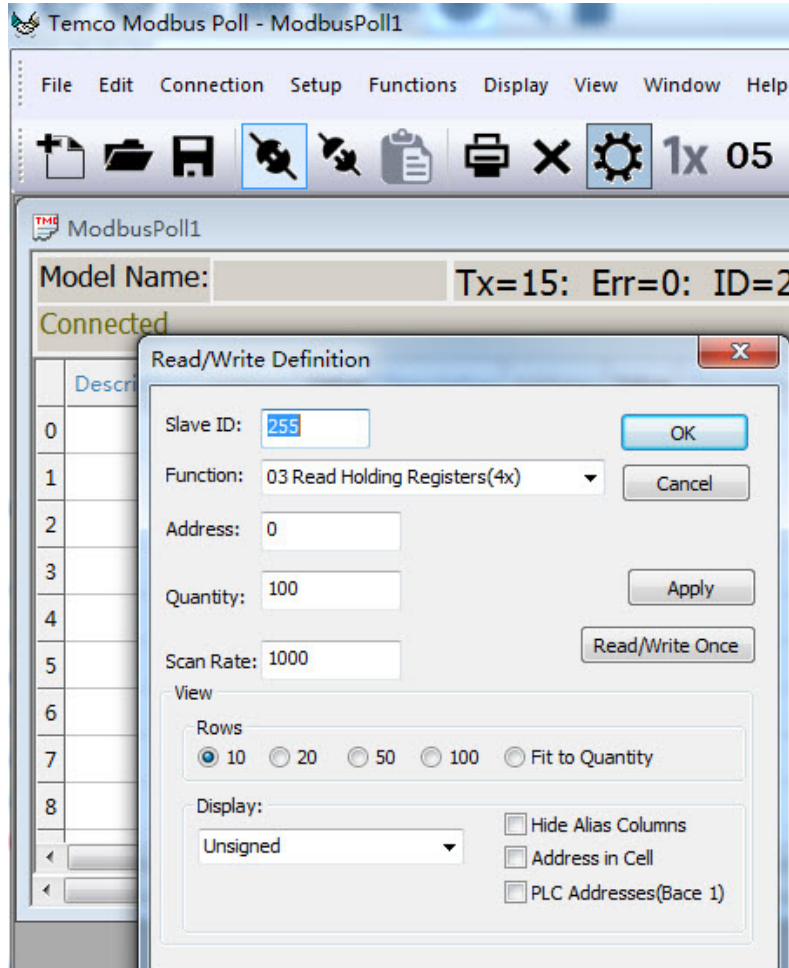

*Port Forwarding

Following are steps for port forwarding:

Step1. Set port forward for router:TCP 502(modbus TCP);UDP 47808(Bacnet port); UDP 1234(Temco private scan).

Step2. Click  to show the tab as below,select "Remote Device"protocol.

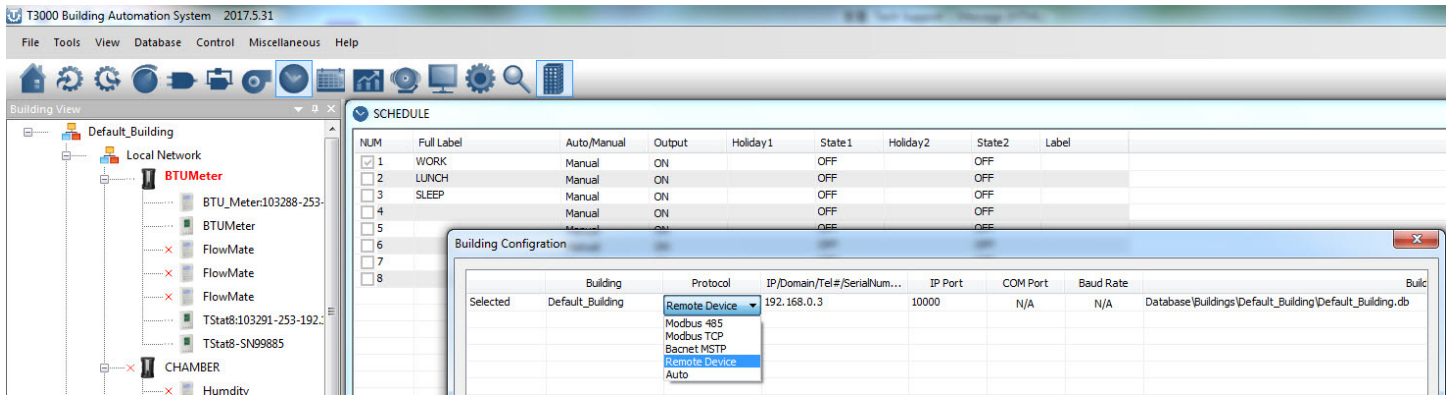

Step3. It will show the tab as below, click to fill out net IP or domain name.

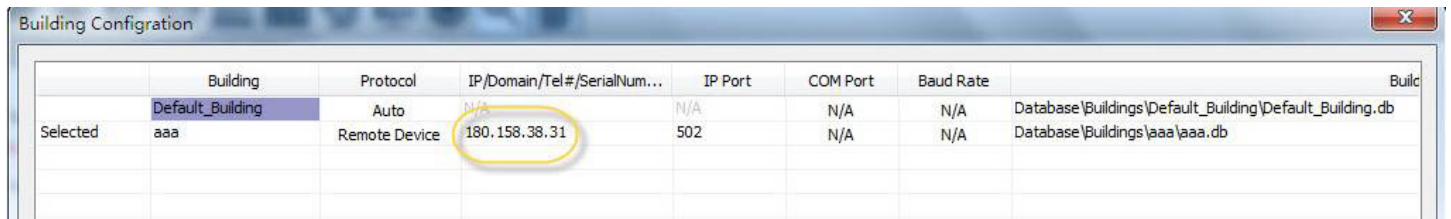

Step4. Scan via T3000 software, the remote device can be connected.

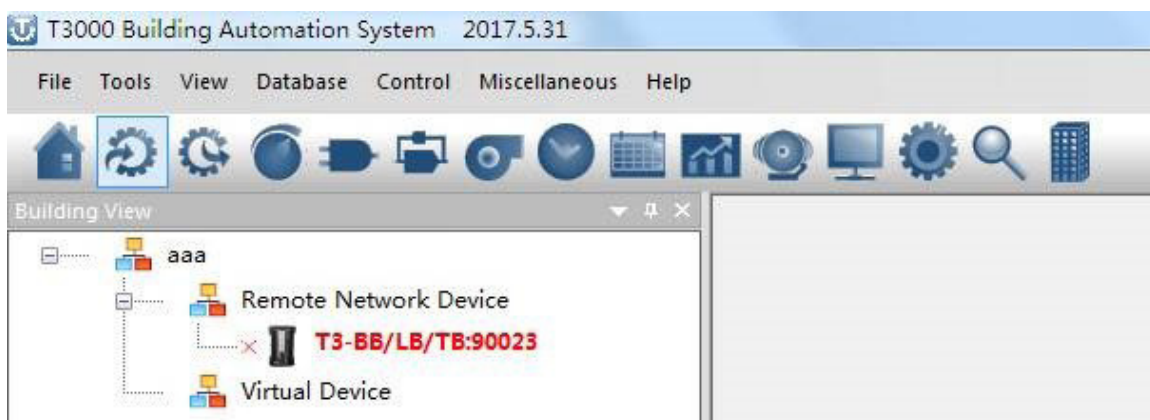
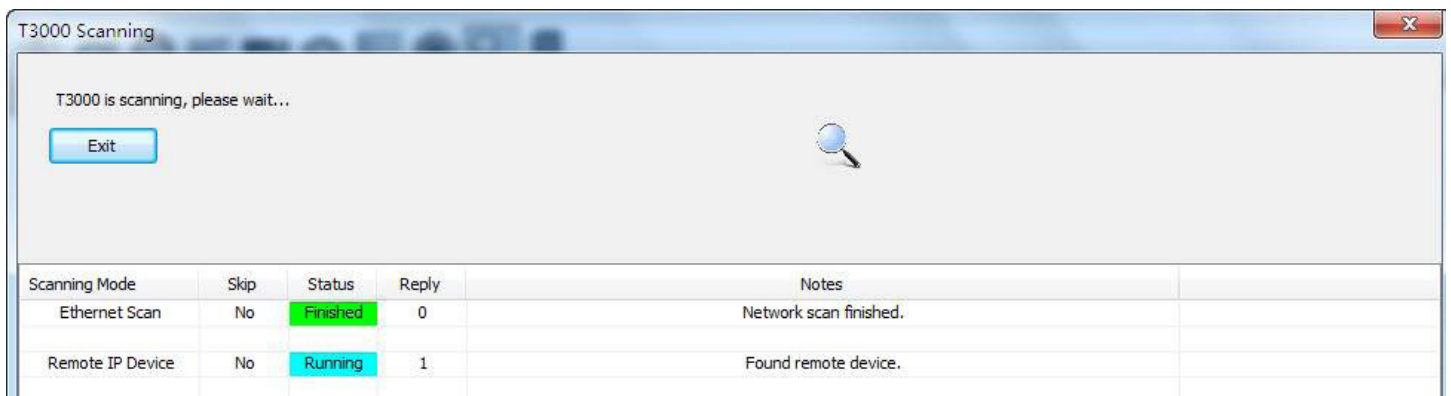

* Adding Custom Devices

Only Temco's device can be discovered by T3-BB serial controller automatically,so we have to add custom device manually. Following are the steps to add custom devices:

Step1.Click  and choose "All Notes..."bar.

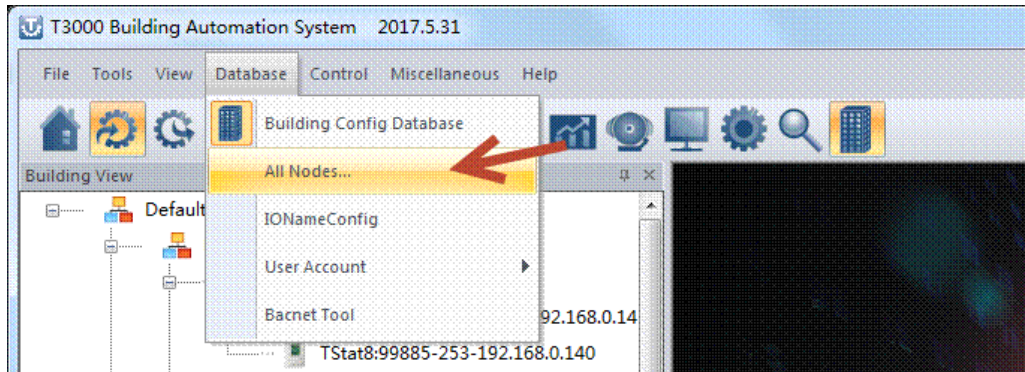

Sep2.If the customer would like to add a device in sub RS485 port,the protocol is Modbus/TCP to Modbus/RS485,we need to confirm which RS485 port to select;If custom device is on RS485 SUB PORT,you need to confirm which port from the three sub net ports current device is on.Then add a new name and ID for the custom device,and you can find the serial number is generated by T3000.

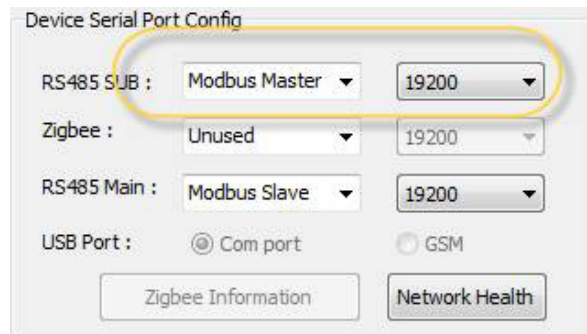

All Nodes Dialog

Buttons: Add, Delete, Del All, Delete Offline, Exit, Add Custom Device

Main Build	Sub Net	Serial ID	Floor	Room	Product Name	IP /Baud Rate	Graphic Name	HardW_Ver
1	Default_Bu	103916	floor1	room1	T3-BB/LB/TB	192.168.0.33	T3000_Default_Building_P	8.0
2	Default_Bu	104170	floor1	room1	T3-BB/LB/TB	192.168.0.33	T3000_Default_Building_P	0
3	Default_Bu	103718	floor1	room1	T3_6CTA	192.168.0.205	T3000_Default_Building_P	1024.0
4	Default_Bu	102629	floor1	room1	T3_6CTA	192.168.0.205	T3000_Default_Building_P	1024.0
5	Default_Bu	65834	floor1	room1	TSTAT8		00_Default_Building_P	23.0
6	Default_Bu	92294	floor1	room1	temcopanel		00_Default_Building_P	23.0
7	Default_Bu	92661	floor1	room1	BTUMeter		00_Default_Building_P	23.0
8	Default_Bu	102643	floor1	room1	LBARM		00_Default_Building_P	7.0
9	Default_Bu	90023	floor1	room1	VFDEExample	192.168.0.15	T3000_Default_Building_P	5.0
10	Default_Bu	103288	floor1	room1	BTU_Meter:1	192.168.0.140	T3000_Default_Building_P	23.0
11	Default_Bu	99885	floor1	room1	TStat8:99885	192.168.0.140	T3000_Default_Building_P	23.0
12	Default_Bu	103345	floor1	room1	Humidity	192.168.0.34	T3000_Default_Building_P	0
13	Default_Bu	65538	floor1	room1	T8_245	192.168.0.97	T3000_Default_Building_P	23.0

Add your own device

Network device

IP: 192 . 168 . 0 . 33

Port: 502

T3-BB Com Port: RS485 SUI

Com port

Comport : COM1

Baudrate : 19200

Product Name: Add New TEST_NAME

Product Type ID: 222

Modbus ID: 2

Serial Number: 16162

Connect Cancel

serial number is generated by T3000, dont mind it

there are 3 sub net port, confirm which port current device is on

name customer device

customer device id

Step3. The custom device will appear in the tree node as below.

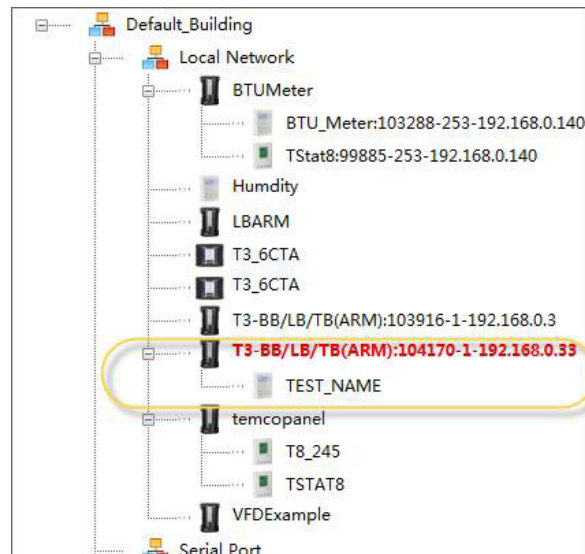

Step4. Choose Control->Program, then we can make a program to read and write custom device's register.

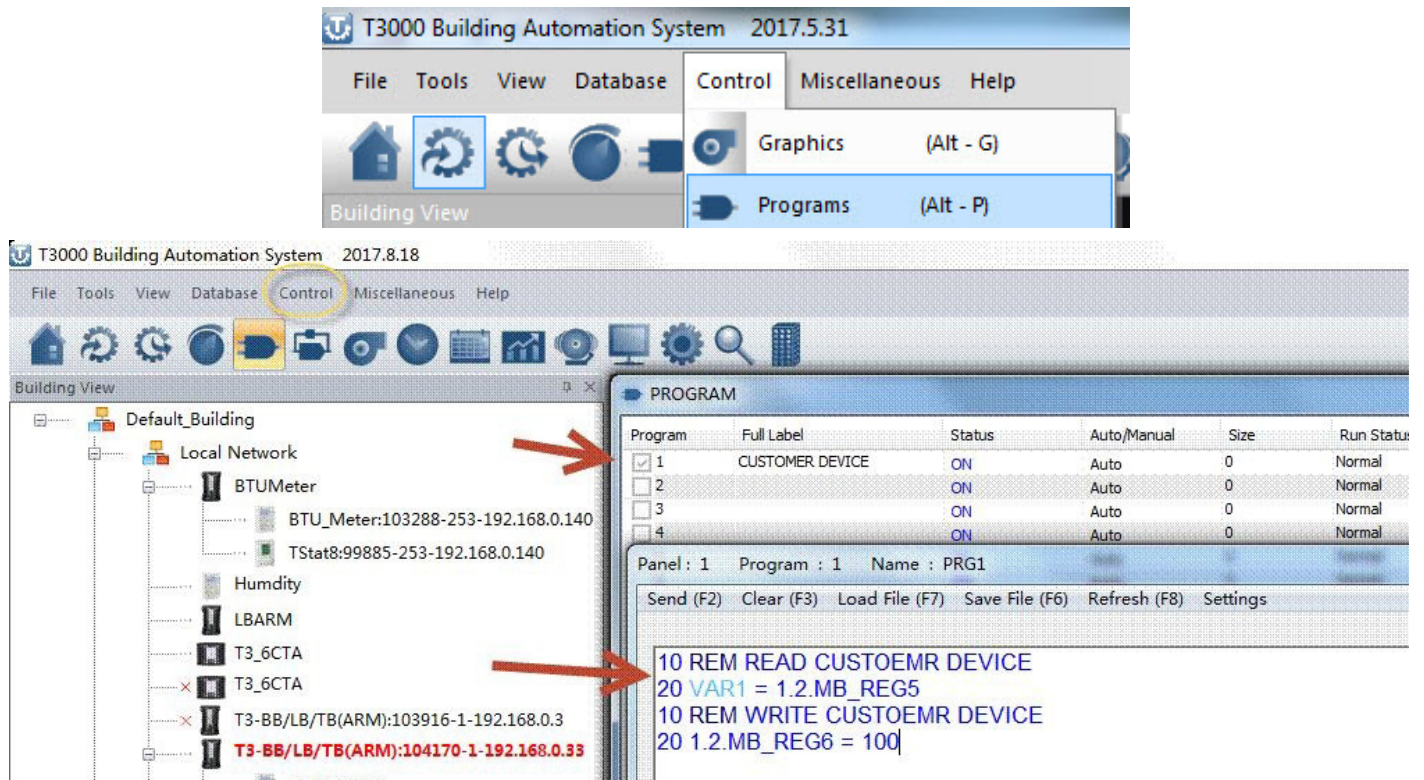

Step5. Click "Network Point table" to check whether the remote points reading is ok.

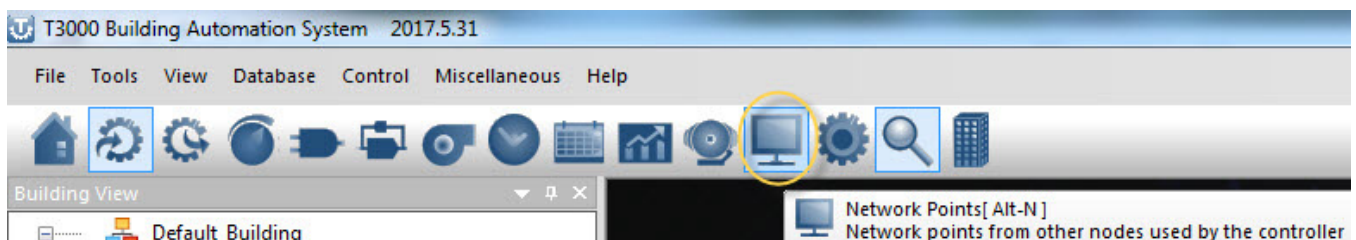

*** Network and remote points support**

T3-serial controller (only new ARM) can support network points and remote points.

1. Network points function

For example, there are panel 1 and 2 in network. We can use 2.2.VARx 2.2.OUTx 2.2.Inx to read or write the network points. Range of x is 1 to 255.

2. Remote Bacnet points

For example, panel 1 is T3000 controller, device 3 is MSTP slave device, which is integrated in only master RS485 port, and this port is set to master MSTP function. We can use 1.3.AVx 1.3.Aix 1.3.DOx 1.3.AOx to read and write remote bacnet points. Range of x is 1 to 255.

3. Remote Modbus points

For example, panel 2 is controller, device 4 is Modbus slave device, which is integrated in master or slave RS485 port, and this port is set to master modbus function. We can use 2.4.MB_REGx or 2.4.REGx to read and write remote modbus points. MB_REG is base 0, and REG is base 1. Range of x is 0 to 2047.

4. Local points

INx (x: 1 - 64), OUTx (x: 1 - 64), VARx (x: 1 - 128), PRGx (x: 1 - 16), GRPx (x: 1 - 16), SCHx (x: 1 - 8), HOLx (x: 1 - 4), PIDx (x: 1 - 16).



Local points:

VARx
Inx
OUTx

In Panel1:

2.2.VARx
2.2.OUTx
2.2.Inx } Network points
x:1~255

1.3.AVx
1.3.AOx
1.3.DOx
1.3.Aix } Remote Bacnet points
x:1~255

In Panel2:

2.4.MB_REGx } Remote Modbus points
x:0~2047
MB_COIL -> 01/05
MB_DISINPUT -> 02
MB_INPUTREG -> 04
MB_REG -> 03/06

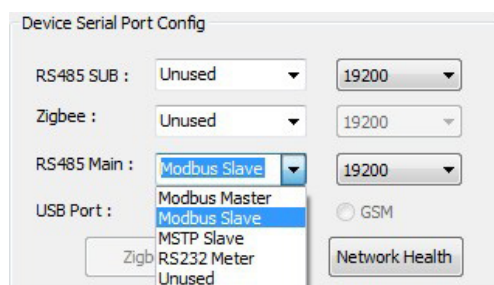

T3 Series Bacnet Programmable Controller

Register List

Address	R/W	Length	Description
0~3	R	4	Reserved for serial numblert
4~5	R	2	firmware Version Number
6	R/W	1	Modbus device address
7	R	1	Prodouct model
8	R	1	Hardware Version Number
9	R	1	PIC rev
12	R	1	UART0 Baudrate. 5 - 9600 , 6 - 19200
14	R	1	ISP Version
18	R/W	1	UART1 Baudrate. 5 - 9600 , 6 - 19200
19	R/W	1	UART2 Baudrate.(UART_1200 = 0, UART_2400 = 1, UART_3600 = 2, UART_4800 = 3, UART_7200 = 4, UART_9600 = 5, UART_19200 = 6, UART_38400 = 7, UART_57600 = 8, UART_115200 = 9, UART_921600 = 10
33	N	1	test cmd, write 77 - reboot, 100 - set default paramer, 111 - erase prg, 150 - clear tstat db
34	R	1	board type, big or small. 1 - big , 2 - samll,3-tiny,4-vav
35	R	1	instance number
36	R	1	station number
39	R/W	1	EN clear tstat db
42	R/W	1	USB MODE
43	R/W	1	EN DYNDNS ,// 0 - no 1 - disable 2 - enable
44	R/W	1	DYNDNS provider, // 0- www.3322.org 1-www.dyndns.com 2 - www.no-ip.com
45	R/W	1	dyndns update timer
46	R/W	1	NETWORK: MSB, MSB-1
47	R/W	1	MSTP NETWORK: MSB, MSB-1
51	R	1	TOP hardware
52	R	1	c8051f023 firmware rev
53	R	1	sm5964 firmware rev
...			

*The register list is very long ,it can be downloaded as an excel spreadsheet (03ModbusBacnetRegisterList.xls) at the following link:<http://tinyurl.com/ybaj9d3u>

T3 Series Bacnet Programmable Controller

1K PT Sensor Accuracy Table:

ACTUAL	RTD ACCURACY +/- °C PT100 Ω ALPHA 0.003850 to DIN 43760 IEC751 DIN EN 60 751			
	B GRADE	A GRADE	BAND 3 (1/3 DIN)	BAND 5 (1/10 DIN)
-200 °C	1.30 °C	0.55 °C	0.39 °C	0.38 °C
-150 °C	1.05 °C	0.45 °C	0.23 °C	0.21 °C
-100 °C	0.80 °C	0.35 °C	0.15 °C	0.12 °C
-90 °C	0.75 °C	0.33 °C	0.14 °C	0.10 °C
-80 °C	0.70 °C	0.31 °C	0.13 °C	0.09 °C
-70 °C	0.65 °C	0.29 °C	0.12 °C	0.08 °C
-60 °C	0.60 °C	0.27 °C	0.11 °C	0.07 °C
-50 °C	0.55 °C	0.25 °C	0.10 °C	0.06 °C
-40 °C	0.50 °C	0.23 °C	0.10 °C	0.06 °C
-30 °C	0.45 °C	0.21 °C	0.09 °C	0.05 °C
-20 °C	0.40 °C	0.19 °C	0.09 °C	0.04 °C
-10 °C	0.37 °C	0.17 °C	0.08 °C	0.03 °C
0 °C	0.30 °C	0.15 °C	0.08 °C	0.03 °C
10 °C	0.35 °C	0.17 °C	0.09 °C	0.04 °C
20 °C	0.40 °C	0.19 °C	0.10 °C	0.04 °C
30 °C	0.45 °C	0.21 °C	0.11 °C	0.05 °C
40 °C	0.50 °C	0.23 °C	0.12 °C	0.06 °C
50 °C	0.55 °C	0.25 °C	0.13 °C	0.07 °C
60 °C	0.60 °C	0.27 °C	0.14 °C	0.08 °C
70 °C	0.65 °C	0.29 °C	0.16 °C	0.09 °C
80 °C	0.70 °C	0.31 °C	0.17 °C	0.10 °C
90 °C	0.75 °C	0.33 °C	0.18 °C	0.11 °C
100 °C	0.80 °C	0.35 °C	0.19 °C	0.12 °C
110 °C	0.85 °C	0.37 °C	0.20 °C	0.13 °C
120 °C	0.90 °C	0.39 °C	0.21 °C	0.14 °C
130 °C	0.95 °C	0.41 °C	0.22 °C	0.15 °C
140 °C	1.00 °C	0.43 °C	0.24 °C	0.15 °C
150 °C	1.05 °C	0.45 °C	0.25 °C	0.16 °C
160 °C	1.10 °C	0.47 °C	0.26 °C	0.17 °C
170 °C	1.15 °C	0.49 °C	0.27 °C	0.18 °C
180 °C	1.20 °C	0.51 °C	0.29 °C	0.19 °C
190 °C	1.25 °C	0.53 °C	0.30 °C	0.21 °C
200 °C	1.30 °C	0.55 °C	0.31 °C	0.22 °C

Set Up WIFI via T3000

Take an example of T3-BB here, connect WIFI via T3000

1. Visit <https://temcocontrols.com/ftp/software/09T3000Software.zip>, download T3000 software and install it;

2. Start T3000 software, click  to scan

